

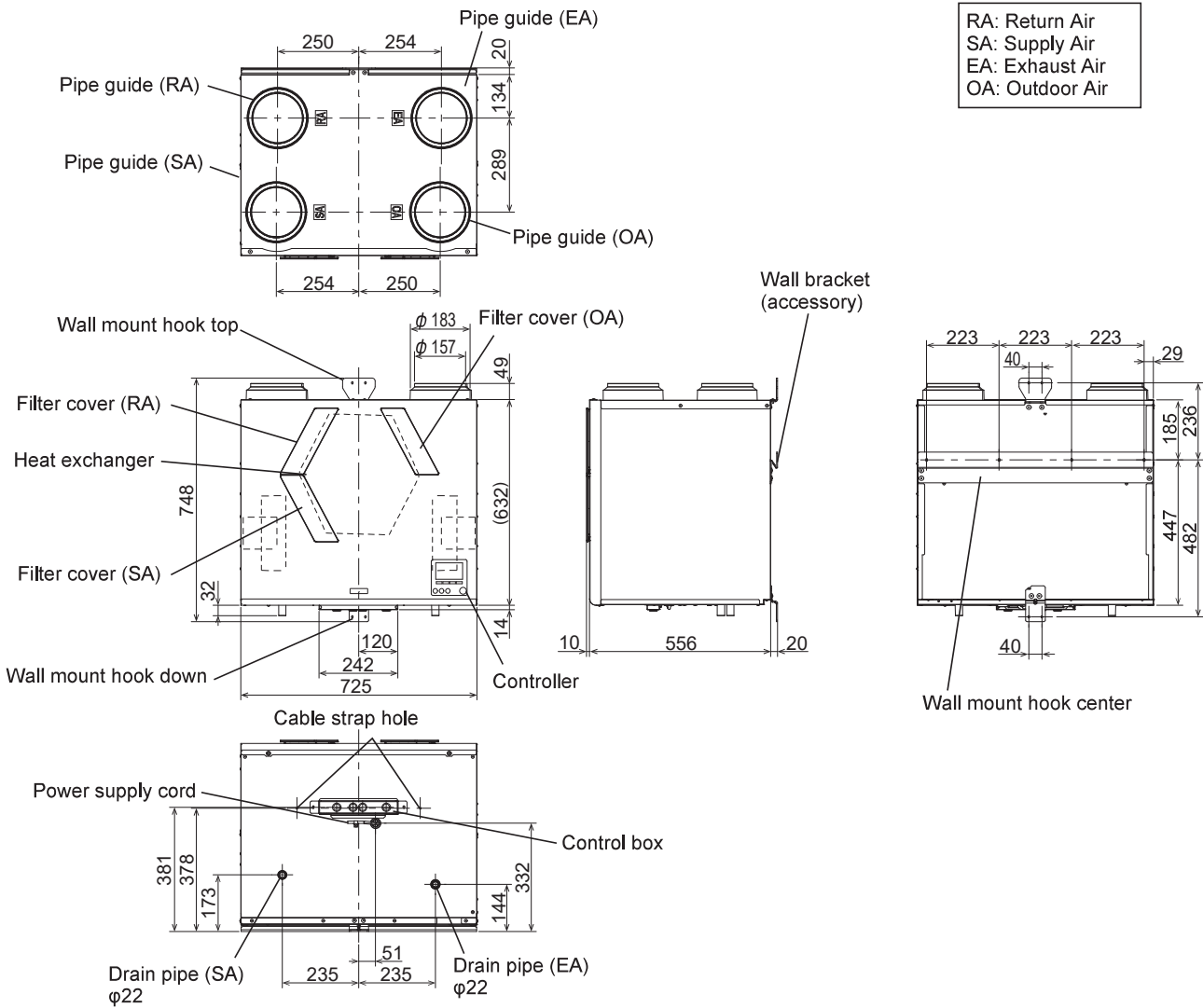

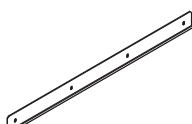



VL-500CZPVU-R-E



Unit (mm)

Accessories

Wall bracket: 1 	Slim-Lossnay connection cable: 1 (100 mm) 	Drain hose fixture: 2 	Washer: 8 	Drain hose: 1 (250 mm) 	Cable strap: 1 
--	--	--	--	--	---